

Data sheet | Item number: 753-506

2-channel digital output; 24 VDC; 0.5 A; Diagnostics

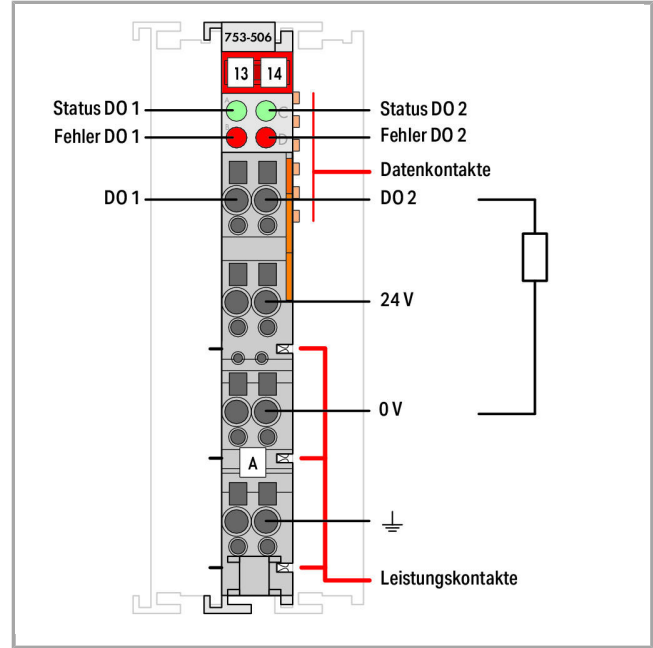

753-506

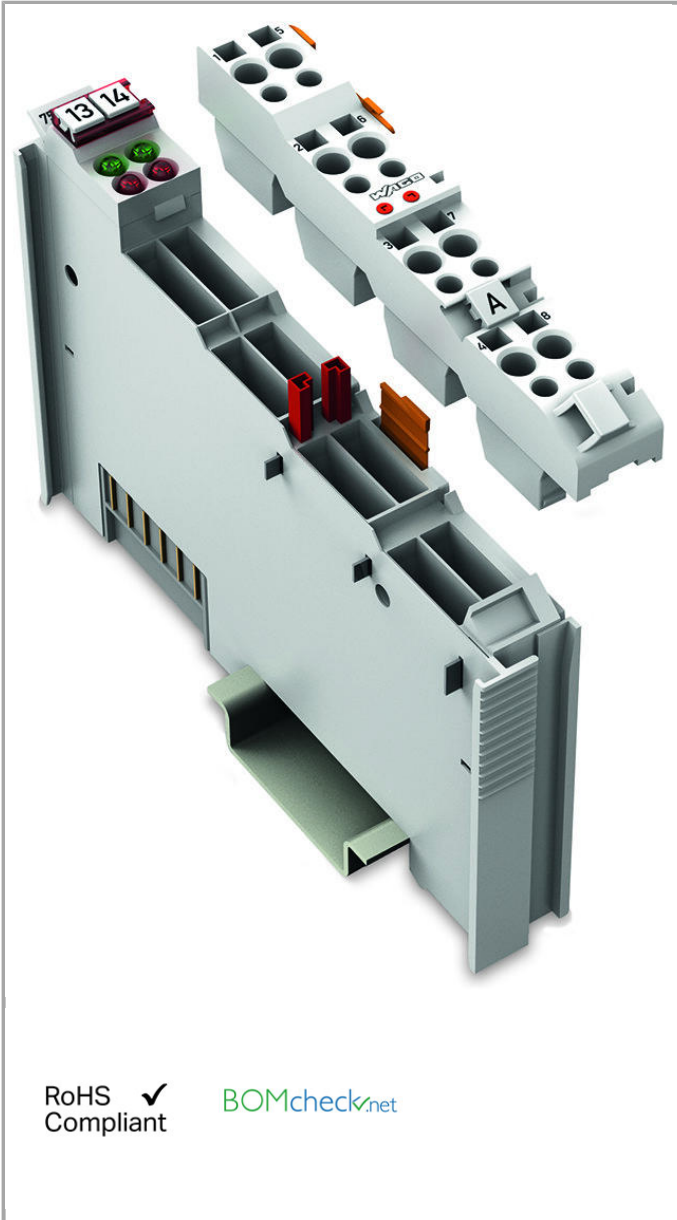

RoHS  Compliant

[BOMcheck.net](https://www.bomcheck.net)

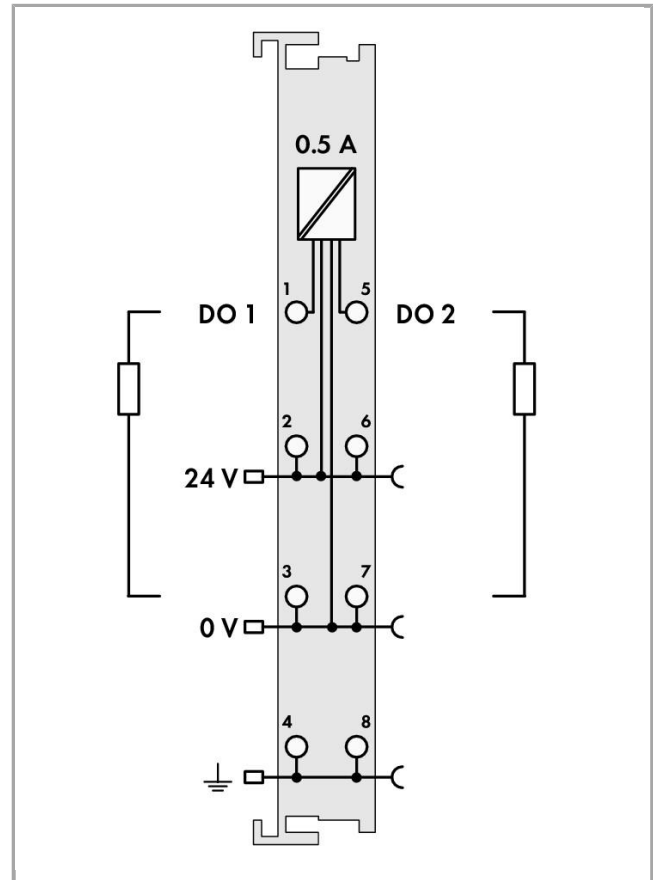
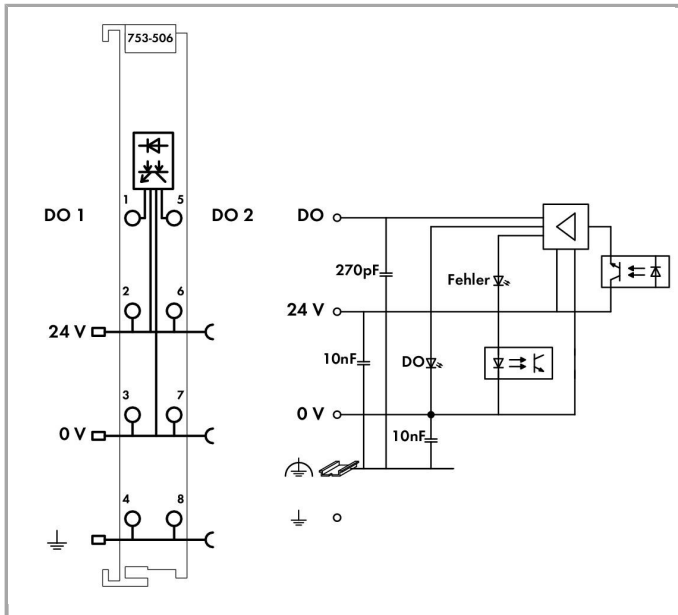

Item description

This digital output module transmits control signals from the automation device to the connected actuators.

All outputs are short-circuit-protected.

This output module detects the following errors: overload, short circuit and wire break.

The status is transmitted to the fieldbus coupler and indicated by LEDs.

Field and system levels are electrically isolated.

Note:

WAGO's 753 Series Pluggable Connectors and Coding Fingers are not included.

Data

Technical Data

Number of digital outputs	2
Total number of channels (module)	2
Type of signal	Voltage



Actuator connection	2 x (2-conductor, 3 Leiter, 4 Leiter)
Output characteristic	high-side switching
Output current per channel	0.5 A
Output current	short-circuit-protected
Switching frequency max.	5 kHz
Type of load	resistive, inductive, lamps
Diagnostics	Open circuit, overload and short circuit
Reverse voltage protection	No
Open-circuit detection	9.5 mA
Short-circuit limitation typ. Pwm	1.5 A
Switching frequency max.	5000 Hz
Inductive load switch-off energy dissipation W (max.)	0.2 J
Max input data width (internal)	2 Bit
Max output data width (internal)	2 Bit
System supply voltage	DC 5 V; via data contacts
Current consumption, system supply (5 V)	15 mA
System and sensor supply voltage)
Field supply voltage	DC 24 V (-15 ... +20 %); über Leistungskontakte (Einspeisung über Messerkontakt; Weiterleitung über Federkontakt)
Current consumption, field supply (module with no external load)	15 mA
Isolation field – system	500 VAC (1 min)
Indicators	LED (A, C) green: Status DO 1, DO 2; LED (B, D) red: Error DO 1, DO 2
Number of incoming power jumper contacts	3
Number of outgoing power jumper contacts	3
Current carrying capacity of the power jumper contacts	10 A

Connection data

Connection technology: In-/Outputs	8 x CAGE CLAMP®
Connection type (1)	Inputs/Outputs
Solid conductor	0.08 ... 2.5 mm ² / 28 ... 14 AWG
Fine-stranded conductor	0.08 ... 2.5 mm ² / 28 ... 14 AWG
Strip length	9 ... 10 mm / 0.35 ... 0.39 inch

Geometrical Data

Width	12 mm / 0.472 inch
Height	69.8 mm / 2.748 inch
Height from upper-edge of DIN-35 rail	62.6 mm / 2.465 inch
Depth	100 mm / 3.937 inch



Mechanical data

Type of mounting	DIN-35 rail
Pluggable connector	yes

Material Data

Color	light gray
Housing material	Polycarbonate, polyamide 6.6
Fire load	1.23 MJ
Weight	54 g
Conformity marking	1

Environmental Requirements

Surrounding air (operating) temperature	0 ... 55 °C
Surrounding air (storage) temperature	-40 ... 85 °C
Protection class	IP20
Degree of pollution (5)	2 per IEC 61131-2
Operating altitude	0 ... 2000 m
Mounting position	horizontal (standing/lying) or vertical
Relative air humidity (no condensation)	95 %
Vibration resistance	acc. to IEC 60068-2-6
Shock resistance	15g per IEC 60068-2-27
EMC immunity to interference	acc. to EN 61000-6-2
EMC emission of interference	acc. to EN 61000-6-4
Exposure to pollutants	Per IEC 60068-2-42 and IEC 60068-2-43
Permissible H ₂ S contaminant concentration at a relative humidity 75 %	10 ppm
Permissible SO ₂ contaminant concentration at a relative humidity 75 %	25 ppm



Commercial data

Product Group	15 (Remote I/O)
Country of origin	DE
GTIN	4045454593254
Customs Tariff No.	85371098990

Approvals / Certificates

Ex-Approvals

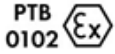
Logo	Approval	Additional Approval Text	Certificate name

	<p>ATEX TUEV Nord Cert GmbH</p>	<p>EN 60079-0</p>	<p>TÜV 07 ATEX 554086 X en.</p>
	<p>TUEV Nord TUEV Nord Cert GmbH</p>	<p>IEC 60079-0</p>	<p>IECEX TUN 09.0001 X</p>
	<p>UL Underwriters Laboratories Inc. (HAZARDOUS LOCATIONS)</p>	<p>ANSI/ISA 12.12.01</p>	<p>E198726 Sec.1</p>

Country specific Approvals



Logo	Approval	Additional Approval Text	Certificate name
	<p>KC National Radio Research Agency</p>	<p>Article 58-2, Clause 3</p>	<p>MSIP- REM-W43- DOM750</p>

















UL-Approvals

Logo	Approval	Additional Approval Text	Certificate name
	<p>UL UL International Netherlands B.V. (ORDINARY LOCATIONS)</p>	<p>UL 508</p>	<p>E175199 Sec.1</p>



















Compatible products

system box















	<p>Item no.: 850-804 IP65 enclosure; Stainless steel; WxHxD (400x123x200 mm); 4 x M20, 16 x M16, 28 x M12 cable grip</p>	<p>850-804</p>
	<p>Item no.: 850-804/000-001 IP65 enclosure; Stainless steel; WxHxD (400x123x200 mm); 2 x M20, 13 x M16, 32 x M12 cable grip</p>	<p>850-804</p>
	<p>Item no.: 850-805 IP65 enclosure; Stainless steel; WxHxD (600x123x200 mm); 4 x M20, 19 x M16, 67 x M12 cable grip</p>	<p>850-805</p>













	Item no.: 850-814/002-000 IP65 enclosure; Sheet steel (RAL 7035); WxHxD (200x120x200 mm); without flange plate	850-814 /002-000
	Item no.: 850-815/002-000 IP65 enclosure; Sheet steel (RAL 7035); WxHxD (300x120x200 mm); without flange plate	850-815 /002-000
	Item no.: 850-816/002-000 IP65 enclosure; Sheet steel (RAL 7035); WxHxD (400x120x200 mm); without flange plate	850-816 /002-000
	Item no.: 850-817/002-000 IP65 enclosure; Sheet steel (RAL 7035); WxHxD (600x120x200 mm); without flange plate	850-817 /002-000
	Item no.: 850-825 IP65 enclosure; Aluminium (RAL 7032); WxHxD (160x100x160 mm); 9 x M12, 4 x M20	850-825
	Item no.: 850-826 IP65 enclosure; Aluminium (RAL 7032); WxHxD (240x100x160 mm); 4 x M20, 4 x M16, 14 x M12 cable grip	850-826
	Item no.: 850-826/002-000 IP65 enclosure; Aluminium (RAL 7035); WxHxD (240x100x160 mm); 4 x M20, 4 x M16, 14 x M12 cable grip	850-826 /002-000
	Item no.: 850-827 IP65 enclosure; Aluminium (RAL 7032); WxHxD (320x100x160 mm); 4 x M20, 8 x M16, 17 x M12 cable grip	850-827
	Item no.: 850-827/002-000 IP65 enclosure; Aluminium (RAL 7035); WxHxD (320x100x160 mm); 4 x M20, 8 x M16, 17 x M12 cable grip	850-827 /002-000
	Item no.: 850-828 IP65 enclosure; Aluminium (RAL 7032); WxHxD (480x100x160 mm); 4 x M20, 10 x M16, 35 x M12 cable grip	850-828
	Item no.: 850-828/002-000 IP65 enclosure; Aluminium (RAL 7035); WxHxD (480x100x160 mm); 4 x M20, 10 x M16, 35 x M12 cable grip	850-828 /002-000
	Item no.: 850-834 IP65 enclosure; Polyester (RAL 7032); WxHxD (164x100x164 mm); 9 x M12, 4 x M20	850-834
	Item no.: 850-835 IP65 enclosure; Polyester (RAL 7032); WxHxD (244x100x164 mm); 4 x M20, 4 x M16, 14 x M12 cable grip	850-835
	Item no.: 850-836 IP65 enclosure; Polyester (RAL 7032); WxHxD (324x100x164 mm); 4 x M20, 8 x M16, 17 x M12 cable grip	850-836
pluggable wiring tier		
	Item no.: 753-110 Plug	753-110
	Item no.: 753-150 753 Series coding elements	753-150

Carrier rail

	Item no.: 210-112 Steel carrier rail; 35 x 7.5 mm; 1 mm thick; 2 m long; slotted; according to EN 60715; "Hole width 25 mm	210-112
	Item no.: 210-113 Steel carrier rail; 35 x 7.5 mm; 1 mm thick; 2 m long; unslotted; according to EN 60715	210-113
	Item no.: 210-114 Steel carrier rail; 35 x 15 mm; 1.5 mm thick; 2 m long; unslotted; similar to EN 60715	210-114
	Item no.: 210-115 Steel carrier rail; 35 x 7.5 mm; 1 mm thick; 2 m long; slotted; according to EN 60715; "Hole width 18 mm	210-115
	Item no.: 210-118 Steel carrier rail; 35 x 15 mm; 2.3 mm thick; 2 m long; unslotted; according to EN 60715	210-118
	Item no.: 210-196 Aluminum carrier rail; 35 x 8.2 mm; 1.6 mm thick; 2 m long; unslotted; similar to EN 60715	210-196
	Item no.: 210-197 Steel carrier rail; 35 x 15 mm; 1.5 mm thick; 2 m long; slotted; similar to EN 60715	210-197
	Item no.: 210-198 Copper carrier rail; 35 x 15 mm; 2.3 mm thick; 2 m long; unslotted; according to EN 60715	210-198
	Item no.: 210-504 Steel carrier rail; 35 x 7.5 mm; 1 mm thick; 2 m long; slotted; galvanized; according to EN 60715	210-504
	Item no.: 210-505 Steel carrier rail; 35 x 7.5 mm; 1 mm thick; 2 m long; unslotted; galvanized; according to EN 60715	210-505
	Item no.: 210-506 Steel carrier rail; 35 x 15 mm; 1.5 mm thick; 2 m long; unslotted; galvanized; similar to EN 60715	210-506
	Item no.: 210-508 Steel carrier rail; 35 x 15 mm; 1.5 mm thick; 2 m long; slotted; galvanized; similar to EN 60715	210-508
shield connection		
	Item no.: 790-108 Shield clamping saddle; 11 mm wide; diameter of compatible conductor	790-108
	Item no.: 790-116 Shield clamping saddle; 19 mm wide; diameter of compatible conductor; 7 ... 16 mm	790-116
	Item no.: 790-124 Shield clamping saddle; 27 mm wide; diameter of compatible conductor; 6 ... 24 mm	790-124
	Item no.: 790-140 Shield clamping saddle; diameter of compatible conductor	790-140
	Item no.: 790-208 Shield clamping saddle; 12.4 mm wide; 3 ... 8 mm	790-208
	Item no.: 790-216 Shield clamping saddle; 21.8 mm wide; 6 ... 16 mm	790-216
	Item no.: 790-220 Shield clamping saddle; 30 mm wide; 6 ... 20 mm	790-220

Marking accessories

	Item no.: 2009-145 Mini-WSB Inline; for Smart Printer; on reel; stretchable 5 - 5.2 mm; plain; snap-on type		2009-145
	Item no.: 2009-145/000-002 Mini-WSB Inline; for Smart Printer; on reel; stretchable 5 - 5.2 mm; plain; snap-on type	/000-002	2009-145
	Item no.: 2009-145/000-005 Mini-WSB Inline; for Smart Printer; on reel; stretchable 5 - 5.2 mm; plain; snap-on type	/000-005	2009-145
	Item no.: 2009-145/000-006 Mini-WSB Inline; for Smart Printer; on reel; stretchable 5 - 5.2 mm; plain; snap-on type	/000-006	2009-145
	Item no.: 2009-145/000-007 Mini-WSB Inline; for Smart Printer; on reel; stretchable 5 - 5.2 mm; plain; snap-on type	/000-007	2009-145
	Item no.: 2009-145/000-012 Mini-WSB Inline; for Smart Printer; on reel; stretchable 5 - 5.2 mm; plain; snap-on type	/000-012	2009-145
	Item no.: 2009-145/000-023 Mini-WSB Inline; for smartPRINTER; on reel; stretchable 5 - 5.2 mm; plain; snap-on type	/000-023	2009-145
	Item no.: 2009-145/000-024 Mini-WSB Inline; for Smart Printer; on reel; stretchable 5 - 5.2 mm; plain; snap-on type	/000-024	2009-145
	Item no.: 248-501 Miniature WSB Quick marking system; plain; Marker width 5 mm; 10 strips with 10 markers per card		248-501
	Item no.: 248-501/000-002 Mini-WSB marking card; as card; not stretchable; plain; snap-on type	/000-002	248-501
	Item no.: 248-501/000-005 Mini-WSB marking card; as card; not stretchable; plain; snap-on type	/000-005	248-501
	Item no.: 248-501/000-006 Mini-WSB marking card; as card; not stretchable; plain; snap-on type	/000-006	248-501
	Item no.: 248-501/000-007 Mini-WSB marking card; as card; not stretchable; plain; snap-on type	/000-007	248-501
	Item no.: 248-501/000-012 Mini-WSB marking card; as card; not stretchable; plain; snap-on type	/000-012	248-501
	Item no.: 248-501/000-017 Mini-WSB marking card; as card; not stretchable; plain; snap-on type	/000-017	248-501

	Item no.: 248-501/000-023 Mini-WSB marking card; as card; not stretchable; plain; snap-on type	248-501 /000-023
	Item no.: 248-501/000-024 Mini-WSB marking card; as card; not stretchable; plain; snap-on type	248-501 /000-024
	Item no.: 709-198 Marking strips	709-198
	Item no.: 750-100 Marker card; as a DIN A4 sheet; plain	750-100
	Item no.: 750-103 Group marker carrier	750-103
	Item no.: 750-106 Group marker carrier	750-106
Supply module		
	Item no.: 750-601 Power Supply; 24 VDC	750-601
	Item no.: 750-602 Power Supply; 24 VDC	750-602
	Item no.: 750-610 Power Supply; 24 VDC; fuse holder; Diagnostics	750-610
	Item no.: 750-612 Power Supply; 0 ... 230 V AC/DC	750-612
	Item no.: 753-602 Power Supply; 24 VDC	753-602
	Item no.: 753-612 Power Supply; 0 ... 230 V AC/DC	753-612

Downloads**Documentation****Manual**

2-channel, 24VDC, 0.5A, with diagnostics short-circuit protected, high-side switching	V 1.3.0	pdf 3.9 MB	Download
--	---------	---------------	----------

Bid Text

753-506 IO, 753	Oct 6, 2014	doc 30.2 kB	Download
--------------------	-------------	----------------	----------

Additional Information

Disposal; Electrical and electronic equipment, Packaging	V 1.0.0	pdf 265.8 kB	Download
--	---------	-----------------	----------



System Description

Overview on WAGO-I/O-SYSTEM 750 approvals	pdf 780.2 kB	Download
750/753 Series I/O-System – General Product Information	pdf 1.7 MB	Download

CAD/CAE - Smart Data

CAD data

3D Download 753-506	URL	Download
---------------------	-----	----------

Product family

750/753 Series I/O-System
[Learn more about the product family.](#)

[Show all products from the family](#)

Subject to changes.
